



FMB110

Advanced tracker

Quick Manual
v1.1

Table of Contents

Know your device	3
Pinout.....	4
Wiring scheme.....	5
Set up your device	6
How to insert Micro-SIM card.....	6
PC Connection (Windows).....	7
How to install USB drivers (Windows).....	7
Configuration (Windows)	7
Quick SMS configuration.....	9
Mounting recommendations	10
LED indications	11
Characteristics	11
Basic characteristics	11
Electrical characteristics.....	13
Safety information	14
Certification and Approvals	15

Warranty	16
Warranty Disclaimer.....	16

Know your device

Top view

Bottom view (without cover)

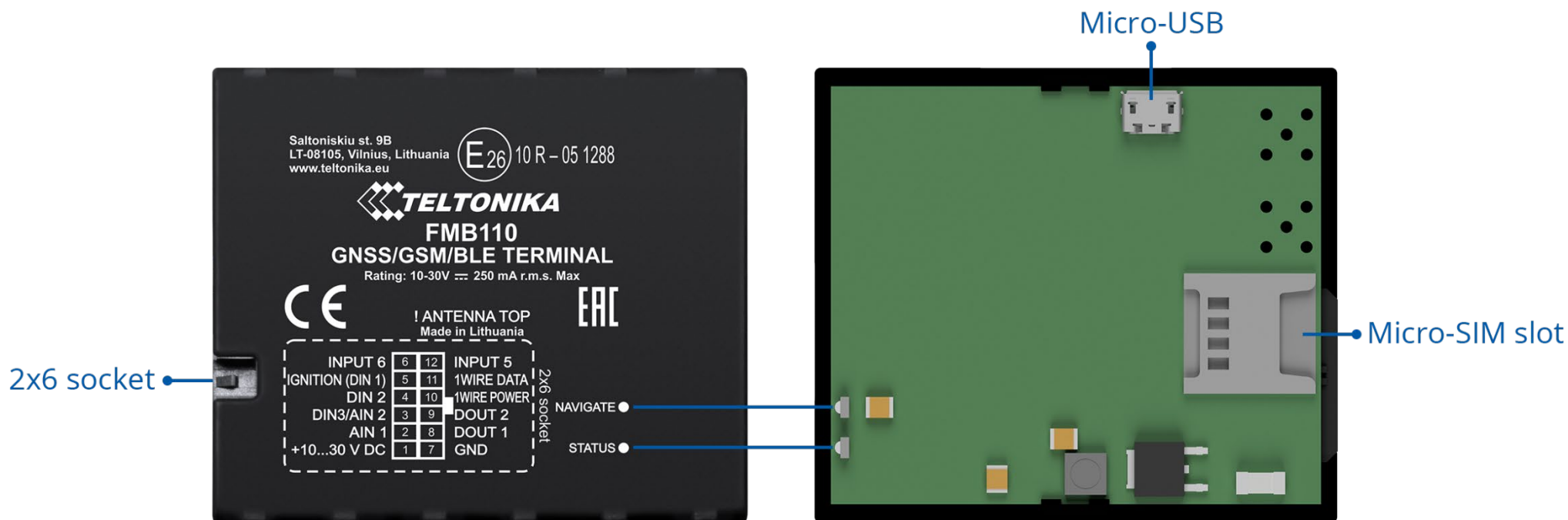

Figure 1 FMB110 device view

Pinout

Table 1 FMB110 2x6 socket pinout

PIN NUMBER	PINNAME	DESCRIPTION
1	VCC (10-30)V DC (+)	Power supply (+10-30 V DC).
2	AIN 1	Analog input, channel 1. Input range: 0-30 V DC.
3	AIN 2 / DIN 3	Analog input, channel 2. Input range: 0-30 V DC / Digital input, channel 3.
4	DIN 2	Digital input, channel 2.
5	DIN 1	Digital input, channel 1.
6	INPUT 6	TX EXT (LVCAN - TX).
7	GND (-)	Ground pin. (10-30)V DC (—)
8	DOUT 1	Digital output, channel 1. Open collector output. Max. 3,3 A DC..
9	DOUT 2	Digital output, channel 2. Open collector output. Max. 3,3 A DC.
10	1WIRE POWER	+3,8 V output for 1-Wire devices.
11	1WIRE DATA	Data for 1-Wire devices.
12	INPUT 5	RX EXT (LVCAN - RX).



Figure 2 FMB110 2x6 socket pinout

Wiring scheme

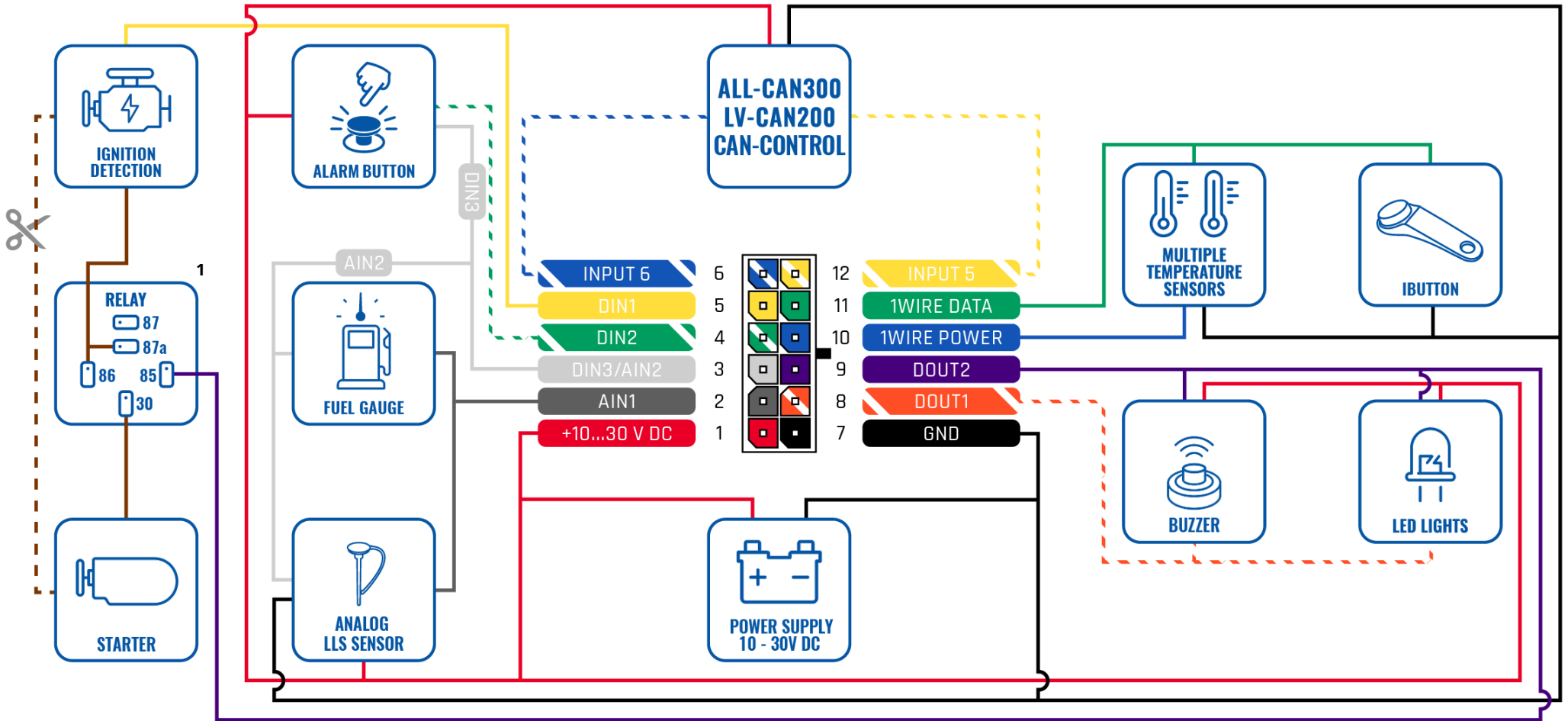

Figure 3 FMB110 Wiring scheme

¹ Automotive relay

Set up your device

How to insert Micro-SIM card

1. Gently remove FMB110 **cover** using **plastic pry tool** from both sides.
2. Insert **Micro-SIM** card as shown with **PIN request disabled** or read our [Wiki](#) how to enter it later in [Teltonika Configurator](#). Make sure that Micro-SIM card **cut-off corner** is pointing forward to slot.
3. After **configuration**, see "[PC Connection \(Windows\)](#)", attach device **cover** back.
4. Device is ready to be mounted.

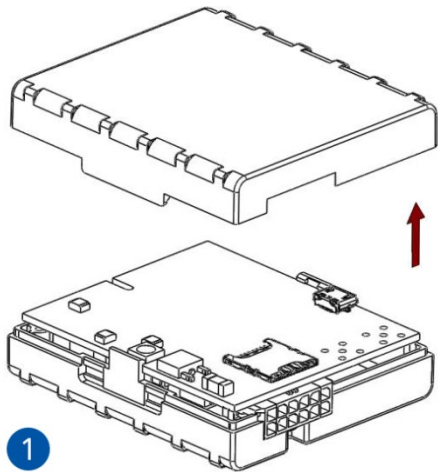

Figure 4 Cover removal

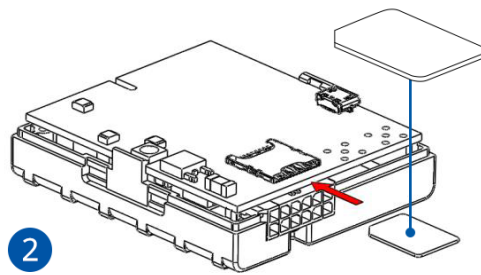

Figure 5 Micro-SIM card insert

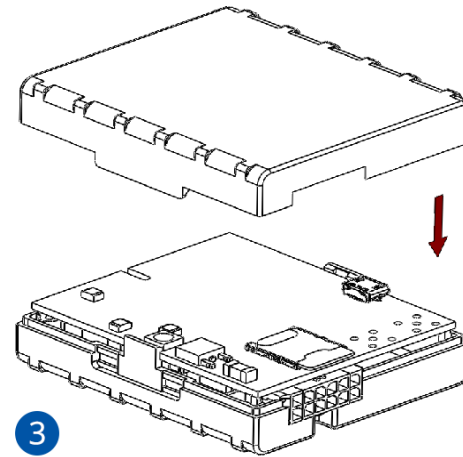

Figure 6 Attaching cover back

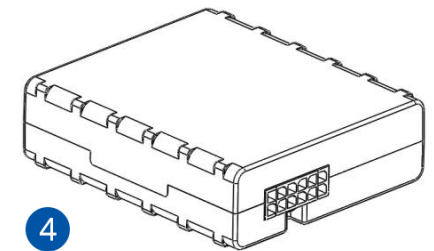

Figure 7 Device is ready

PC Connection (Windows)

1. Power-up FMB110 with **DC voltage (10 – 30 V)** power supply using **supplied power cable**. LED's should start blinking, see "[LED indications](#)".
2. Connect device to computer using **Micro-USB cable** or **Blue-tooth** connection:
 - Using **Micro-USB cable**
 - You will need to install USB drivers, see "[How to install USB drivers \(Windows\)](#)"
 - Using **Blue-tooth**
 - FMB110 Blue-tooth is enabled by default. Turn on **Blue-tooth** on your PC, then select **Add Blue-tooth or other device > Blue-tooth**. Choose your device named – "**FMBxxx_last_7_imei_digits**", without **LE** in the end. Enter default password **5555**, press **Connect** and then select **Done**.
3. You are now ready to use the device on your computer.

How to install USB drivers (Windows)

1. Please download COM port drivers from [here](#).
2. Extract and run **TeltonikaCOMDriver.exe**.
3. Click **Next** in driver installation window.
4. In the following window click **Install** button.

Setup will continue installing the driver and eventually the confirmation window will appear. Click **Finish** to complete the setup.

Configuration (Windows)

At first FMB110 device will have default factory settings set. These settings should be changed according to the user's needs. Main configuration can be performed via [Teltonika Configurator](#) software. Get the latest **Configurator** version [here](#). Configurator operates on **Microsoft Windows OS** and uses prerequisite **MS .NET Framework**. Make sure you have the correct version installed.

Table 2 MS .NET requirements

MS.NET REQUIREMENTS

Operating system	MS .NET Framework version	Version	Links
Windows Vista Windows 7 Windows 8.1 Windows 10	MS .NET Framework 4.6.2	32 and 64 bit	www.microsoft.com

Downloaded **Configurator** will be in compressed archive. Extract it and launch **Configurator.exe**. After launch software language can be changed by clicking  in the right bottom corner ([Figure 8 Language selection](#)).

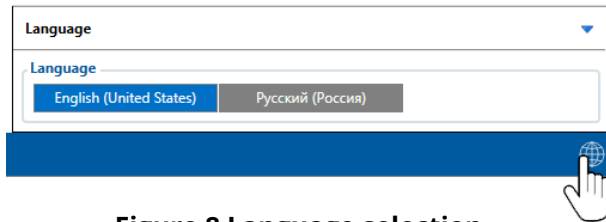

Figure 8 Language selection

Configuration process begins by pressing on connected device (**Figure 9 Device connected via USB**).



Figure 9 Device connected via USB

After connection to Configurator **Status window** will be displayed (**Figure 10 Configurator Status window**).

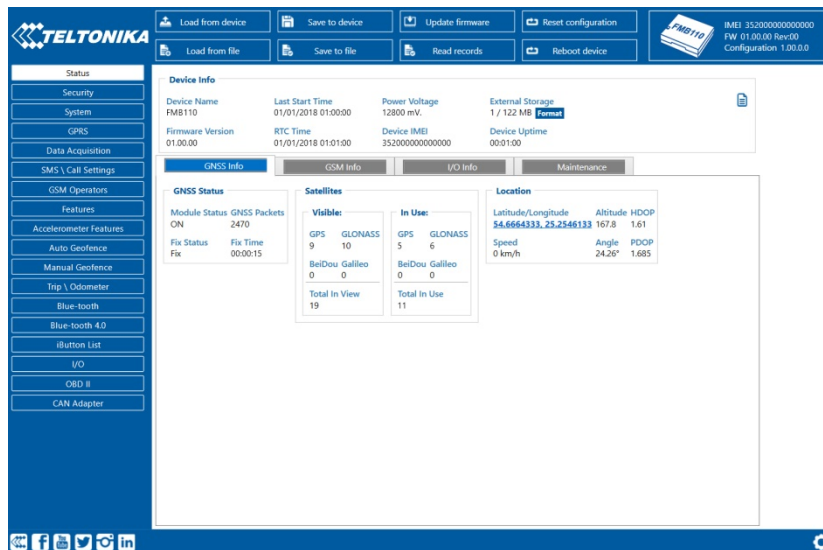

Figure 10 Configurator Status window

Various **Status window** tabs display information about **GNSS**, **GSM**, **I/O**, **Maintenance** and etc. FMB110 has one user editable profile, which can be loaded and saved to the device. After any modification of configuration the changes need to be saved to device using **Save to device** button. Main buttons offer following functionality:

1. **Load from device** – loads configuration from device.
2. **Save to device** – saves configuration to device.
3. **Load from file** – loads configuration from file.
4. **Save to file** – saves configuration to file.
5. **Update firmware** – updates firmware on device.
6. **Read records** – reads records from the device.
7. **Reboot device** – restarts device.
8. **Reset configuration** – sets device configuration to default.

Most important configurator section is **GPRS** – where all your server and **GPRS settings** can be configured and **Data Acquisition** – where data acquiring parameters can be configured. More details about FMB110 configuration using Configurator can be found in our **Wiki**.

Quick SMS configuration

Default configuration has optimal parameters present to ensure best performance of track quality and data usage.

Quickly set up your device by sending this SMS command to it:

```
" setparam 2001:APN;2002:APN_username;2003:APN_password;2004:Domain;2005:Port;2006;0"
```

Note: Before SMS text, two space symbols should be inserted.

GPRS settings:

- 2001 – APN
- 2002 – APN username (if there are no APN username, empty field should be left)
- 2003 – APN password (if there are no APN password, empty field should be left)

Server settings:

- 2004 – Domain
- 2005 – Port
- 2006 – Data sending protocol (0 – TCP, 1 – UDP)



Default configuration settings

Movement and ignition detection:

- Vehicle movement will be detected by accelerometer
- Ignition will be detected by vehicle power voltage between 13,2 – 30 V

Device makes a record **On Moving** if one of these events happen:

- 300 seconds passes
- Vehicle turns 10 degrees
- Vehicle drives 100 meters
- Speed difference between last coordinate and current position is greater than 10 km/h

Device makes a record **On Stop** if:

- 1 hour passes while vehicle is stationary and ignition is off

Records sending to server:

- If device has made a record it is sent to the server every 120 seconds

After successful SMS configuration, FMB110 device will **synchronize time** and **update records** to **configured server**. Time intervals and default I/O elements can be changed by using [Teltonika Configurator](#) or [SMS parameters](#).

Mounting recommendations

- Connecting wires
 - Wires should be connected while the module is not plugged in.
 - Wires should be fastened to stable wires or other non-moving parts. Any heat emitting and/or moving objects should be kept away from the wires.
 - There should be no exposed wires. If factory isolation was removed while connecting the wires, the isolation material should be applied.
 - If the wires are placed in the exterior or in places where they can be damaged or exposed to heat, humidity, dirt, etc., additional isolation should be applied and the wires should not be loose.
 - Wires cannot be connected to the board computers or control units.
- Connecting power source
 - Be sure that after the car computer goes to sleep mode, power might be still available on the power wires. Depending on the car model, this may happen in 5 to 30 minutes period.
 - When the module is connected, measure the voltage again to make sure it did not decrease.
 - It is recommended to connect to the main power cable in the fuse box.
- 3 A, 125 V external fuse shall be used.
- Connecting ignition wire
 - Be sure to check if it is a real ignition wire i. e. power does not disappear after starting the engine.
 - Check if this is not an ACC wire (when key is in the first position, most of the vehicle electronics are available).
 - Check if power is still available when you turn off any of vehicles devices.
 - Ignition is connected to the ignition relay output. As alternative, any other relay, which has power output when ignition is on, may be chosen.
- Connecting ground wire
 - Ground wire is connected to the vehicle frame or metal parts that are fixed to the frame.
 - If the wire is fixed with the bolt, the loop must be connected to the end of the wire.
 - For better contact scrub paint from the spot where loop is going to be connected.

LED indications

Table 3 Navigation LED indications

BEHAVIOUR	MEANING
Permanently switched on	GNSS signal is not received
Blinking every second	Normal mode, GNSS is working
Off	GNSS is turned off because: Device is not working or Device is in sleep mode
Blinking fast constantly	Device firmware is being flashed

Table 4 Status LED indications

BEHAVIOUR	MEANING
Blinking every second	Normal mode
Blinking every two seconds	Sleep mode
Blinking fast for a short time	Modem activity
Off	Device is not working or Device is in boot mode

Characteristics

Basic characteristics

Table 5 Basic characteristics

MODULE	
Name	TM2500
Technology	GSM, GPRS, GNSS, BLUE-TOOTH
GNSS	
GNSS	GPS, GLONASS, GALILEO, BEIDOU, SBAS, QZSS, DGPS, AGPS
Receiver	33 channel
Tracking sensitivity	-165 dBm
Accuracy	< 3 m
Hot start	< 1 s
Warm start	< 25 s
Cold start	< 35 s
CELLULAR	
Technology	GSM
2G bands	Quad-band 850 / 900 / 1800 / 1900 MHz
Data transfer	GPRS Multi-Slot Class 12 (up to 240 kbps), GPRS Mobile Station Class B
Data support	SMS (text/data)

POWER

Input voltage range	10 - 30 V DC with overvoltage protection
Power consumption	At 12V < 5 mA (Ultra Deep Sleep)
	At 12V < 6 mA (Deep Sleep)
	At 12V < 7 mA (Online Deep Sleep)
	At 12V < 17 mA (GPS Sleep)
	At 12V < 35 mA (nominal)

BLUE-TOOTH

Specification	4.0 + LE
Supported peripherals	Temperature and Humidity sensor , Headset , OBDII dongle , Inateck Barcode Scanner

INTERFACE

Digital Inputs	3
Digital Outputs	2
Analog Inputs	2
CAN Adapter inputs	1
1-Wire	1
GNSS antenna	Internal High Gain
GSM antenna	Internal High Gain
USB	2.0 Micro-USB
LED indication	2 status LED lights
SIM	Micro-SIM + eSIM
Memory	128MB internal flash memory

PHYSICAL SPECIFICATION

Dimensions	79 x 43 x 12 mm (L x W x H)
Weight	50 g

OPERATING ENVIRONMENT

Operating temperature	-25 °C to +55 °C
Storage temperature	-40 °C to +70 °C
Operating humidity	5% to 95% non-condensing
Ingress Protection Rating	IP41

FEATURES

Sensors	Accelerometer
Scenarios	Green Driving , Over Speeding detection , Jamming detection , GNSS Fuel Counter , DOUT Control Via Call , Excessive Idling detection , Immobilizer , iButton Read Notification , Towing detection , Crash detection , Auto Geofence , Manual Geofence , Trip
Sleep modes	GPS Sleep , Online Deep Sleep , Deep Sleep , Ultra Deep Sleep
Configuration and firmware update	FOTA Web , FOTA , Teltonika Configurator (USB, Blue-tooth), FMBT mobile application (Configuration)
SMS	Configuration, Events, DOUT control, Debug
GPRS commands	Configuration, DOUT control, Debug
Time Synchronization	GPS, NITZ, NTP
Fuel monitoring	LLS (Analog), LV-CAN200 , ALL-CAN300 , OBDII dongle , CAN-CONTROL
Ignition detection	Digital Input 1, Accelerometer, External Power Voltage, Engine RPM (CAN Adapters, OBDII dongle)

Electrical characteristics

Table 6 Electrical characteristics

CHARACTERISTIC DESCRIPTION	VALUE			
	MIN.	TYP.	MAX.	UNIT
SUPPLY VOLTAGE				
Supply Voltage (Recommended Operating Conditions)	+10		+30	V
DIGITAL OUTPUT (OPEN DRAIN GRADE)				
Drain current (Digital Output OFF)			120	μA
Drain current (Digital Output ON, Recommended Operating Conditions)		0.1	0.5	A
Static Drain-Source resistance (Digital Output ON)		400	600	mΩ
DIGITAL INPUT				
Input resistance (DIN1)	47			kΩ
Input resistance (DIN2)	47			kΩ
Input voltage (Recommended Operating Conditions)	0		Supply voltage	V
Input Voltage threshold (DIN1)		7.5		V
Input Voltage threshold (DIN2)		2.5		V

ANALOG INPUT

Input voltage (Recommended Operating Conditions), Range 1	0		+10	V
Input resistance, Range 1		150		kΩ
Measurement error on 12V, Range 1		0.9		%
Additional error on 12 V, Range 1		108		mV
Measurement error on 30 V, Range 1		0.33		%
Additional error on 30 V, Range 1		88		mV
Input Voltage (Recommended Operating Conditions), Range 2	0		+30	V
Input resistance, Range 2		150		kΩ
Measurement error on 12 V, Range 2		0.9		%
Additional error on 12 V, Range 2		108		mV
Measurement error on 30 V, Range 2		0.33		%
Additional error on 30 V, Range 2		88		mV

OUTPUT SUPPLY VOLTAGE 1-WIRE

Supply voltage	+4.5		+4.7	V
Output inner resistance		7		Ω
Output current ($U_{out} > 3.0$ V)		30		mA
Short circuit current ($U_{out} = 0$)		75		mA

Safety information

This message contains information on how to operate FMB110 safely. By following these requirements and recommendations, you will avoid dangerous situations. You must read these instructions carefully and follow them strictly before operating the device!

- The device uses SELV limited power source. The nominal voltage is +12 V DC. The allowed voltage range is +10..+30 V DC.
- To avoid mechanical damage, it is advised to transport the device in an impact-proof package. Before usage, the device should be placed so that its LED indicators are visible. They show the status of device operation.
- When connecting the 2x6 connector wires to the vehicle, the appropriate jumpers of the vehicle power supply should be disconnected.
- Before unmounting the device from the vehicle, the 2x6 connector must be disconnected. The device is designed to be mounted in a zone of limited access, which is inaccessible to the operator. All related devices must meet the requirements of EN 60950-1 standard.
The device FMB110 is not designed as a navigational device for boats.



Do not disassemble the device. If the device is damaged, the power supply cables are not isolated or the isolation is damaged, DO NOT touch the device before unplugging the power supply.



All wireless data transferring devices produce interference that may affect other devices which are placed nearby.



The device must be connected only by qualified personnel.



The device must be firmly fastened in a predefined location.



The programming must be performed using a PC with autonomic power supply.



Installation and/or handling during a lightning storm is prohibited.



The device is susceptible to water and humidity.

Certification and Approvals

- [FMB110 CE/RED](#)
- [FMB110 E-Mark](#)
- [FMB110 EAC](#)
- [FMB110 RoHS](#)
- [FMB110 REACH](#)
- [FMB110 Declaration of IMEI assignment](#)

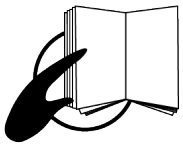

This sign on the package means that it is necessary to read the User's Manual before your start using the device. Full User's Manual version can be found in our [Wiki](#).



This sign on the package means that all used electronic and electric equipment should not be mixed with general household waste.



Hereby, Teltonika declare under our sole responsibility that the above described product is in conformity with the relevant Community harmonization: European Directive 2014/53/EU (RED).

Warranty

TELTONIKA guarantees its products to be free of any manufacturing defects for a period of **24 months**. With additional agreement we can agree on a different warranty period, for more detailed information please contact our sales manager.

Contact us teltonika.it/company/contacts

If a product should fail within this specific warranty time, the product can be:

- Repaired
- Replaced with a new product
- Replaced with an equivalent repaired product fulfilling the same functionality
- TELTONIKA can also repair products that are out of warranty at an agreed cost.

Warranty Disclaimer

TELTONIKA PRODUCTS ARE INTENDED TO BE USED BY PERSONS WITH TRAINING AND EXPERIENCE. ANY OTHER USE RENDERS THE LIMITED WARRANTIES EXPRESSED HEREIN AND ALL IMPLIED WARRANTIES NULL AND VOID AND SAME ARE HEREBY EXCLUDED. ALSO EXCLUDED FROM THIS LIMITED WARRANTY ARE ANY AND ALL INCIDENTAL OR CONSEQUENTIAL DAMAGES INCLUDING BUT NOT LIMITED TO, LOSS OF USE OR REVENUE, LOSS OF TIME, INCONVENIENCE OR ANY OTHER ECONOMIC LOSS.

More information can be found at teltonika.it/warranty-repair